

VALVOLE UNIDIREZIONALI
ONE-WAY VALVES

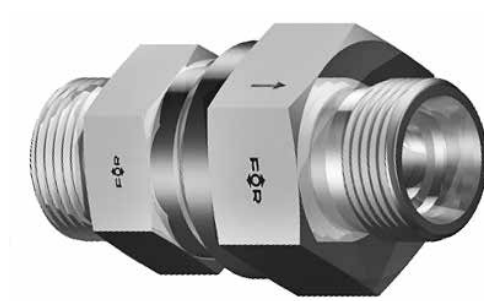



La FOR rafforza la propria gamma prodotti con l'introduzione delle valvole unidirezionali. Tali valvole permettono il libero passaggio in un solo senso (quello indicato dalla freccia) e lo impediscono nel senso contrario. Azionate direttamente dal fluido che le attraversa, vengono normalmente impiegate come dispositivi di sicurezza, consentendo di mantenere in pressione una parte del circuito pur mandando a scarico l'alimentazione. La pressione di apertura della valvola è 1 bar nella versione standard. Altre pressioni sono realizzabili a richiesta seguendo la codifica riportata nella seguente tabella.

FOR widens its product range with the introduction of non-return valves. These valves allow free flow in one direction only (indicated by the arrow) and shut it off in the opposite direction. Actuated directly by the fluid which passes through them, it is normally used as safety devices, allowing to maintain pressure in a part of the circuit while sending to drain the power. The opening pressure of the valve is 1 bar in the standard version. Other opening pressures are available on request following the coding shown in the following table.

| CODICE PRESSIONE PRESSURE CODE | PRESSIONE DI APERTURA (BAR) OPENING PRESSURE (BAR) |
|---|---|
| E | 0.2 |
| D | 0.5 |
| A | 1 (standard) |
| C | 2 |
| B | 3 |
| F | 4 |
| G | 5 |
| H | 6 |

Esempio / Example: A302510/0606A Pressione di apertura 1 Bar / Opening pressure 1 Bar

Esempio / Example: A302510/0606E Pressione di apertura 0.2 Bar / Opening pressure 0.2 Bar

SCHEMA VALVOLA VALVE SCHEME

- 1 Supporto Valvola / Valve Support
- 2 O-Ring / O-Ring
- 3 Molla / Spring
- 4 Rondella di Appoggio / Thrust Washer
- 5 Guarnizione di Tenuta / Seal
- 6 Cono Otturatore / Shutter

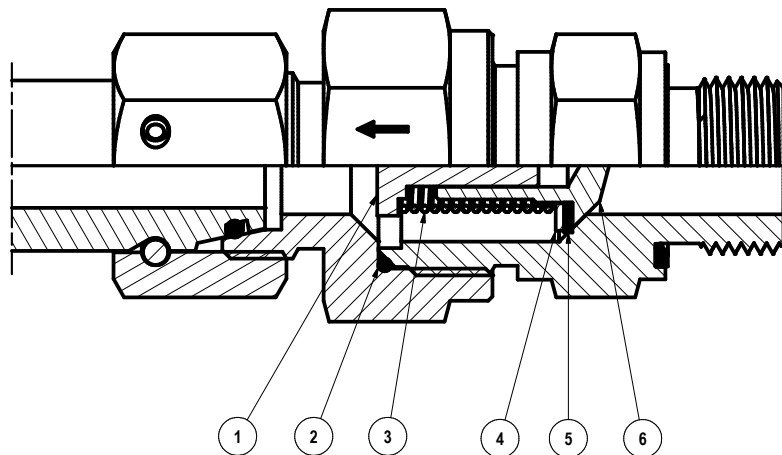

Il corpo della valvola è realizzato in acciaio al carbonio con trattamento di zincatura superficiale esente da Cromo Esavalente in accordo alla Direttiva Europea 2000/53/CE secondo gli standard previsti dalle specifiche ASTM-B-117 e ISO 9227 che garantisce una resistenza di oltre 400 ore all'ossidazione bianca in nebbia salina. Le guarnizioni interne di tenuta sono realizzate in NBR e a richiesta in FKM.

The valve body is made of carbon steel with a Hexavalent Chrome free zinc plating surface treatment according to European Directive 2000/53 / EC. We guarantee a resistance of over 400 hours to white rust in salt spray test according to standard ASTM-B-117 and ISO 9227. The inner seals are made of NBR and FKM at request.

**CODIFICA VALVOLE
UNIDIREZIONALI
ENCODING VALVES**

Direzione Flusso / Flow Direction
←

**TIPO ST
ST TYPE**

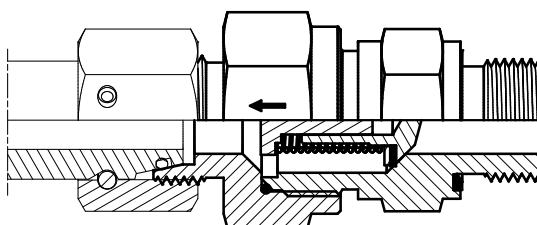

**TIPO TS
TS TYPE**

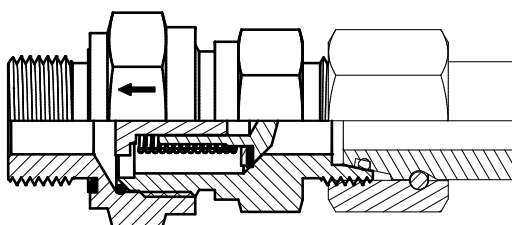

**TIPO TT
TT TYPE**

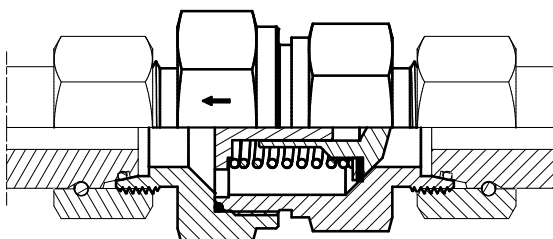

GRAFICI CADUTA DI PRESSIONE PRESSURE DROP CHARTS

I grafici riportati sono stati ottenuti utilizzando olio idraulico con viscosità 30 cSt alla temperatura di test di 50°C. Il dato più alto di portata rappresentato sui grafici si riferisce alla velocità massima del fluido consentita di 8 m/sec.

The charts were obtained using hydraulic oil with a viscosity of 30 cSt at the temperature of the test of 50°C. The highest flow value represented on charts refers to the maximum speed of the fluid allowed to 8 m/sec.

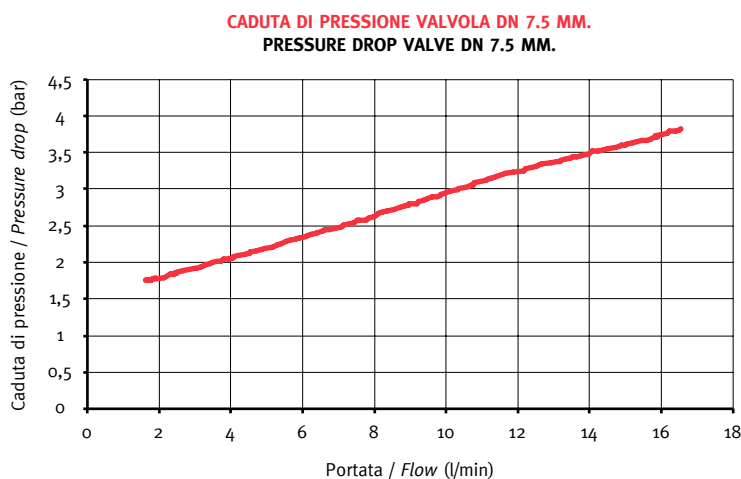
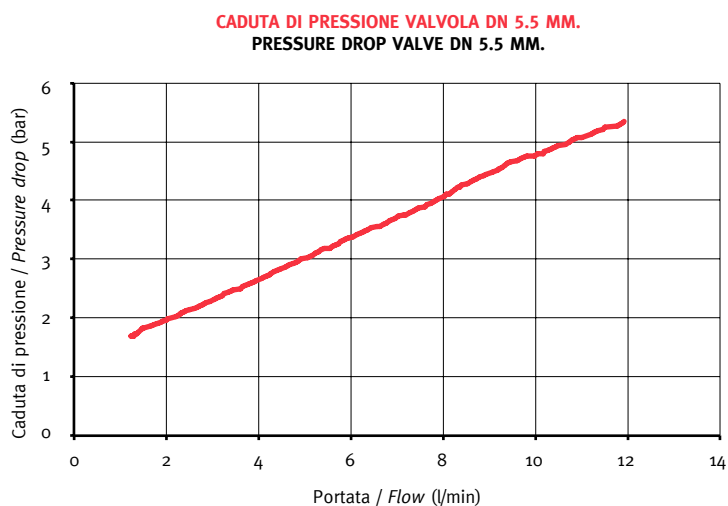
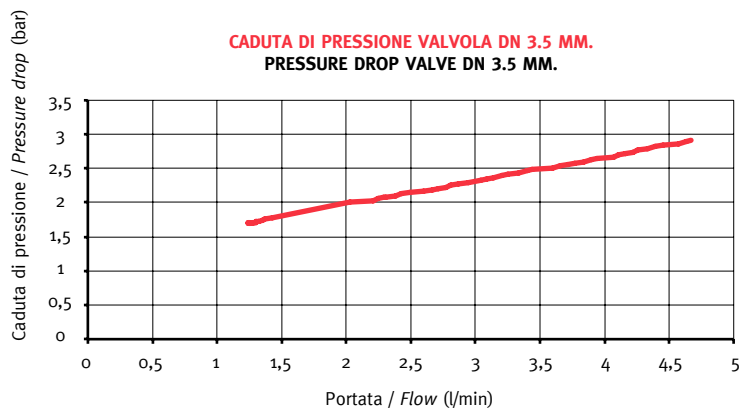

**CADUTA DI PRESSIONE VALVOLA DN 9.5 MM.
PRESSURE DROP VALVE DN 9.5 MM.**

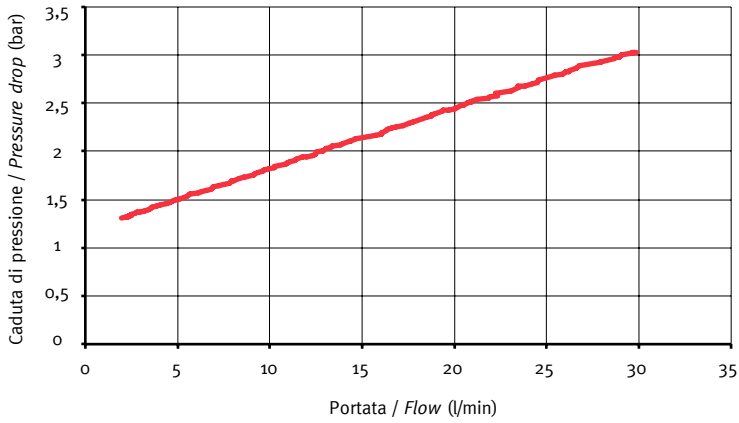

**CADUTA DI PRESSIONE VALVOLA DN 11.5 MM.
PRESSURE DROP VALVE DN 11.5 MM.**

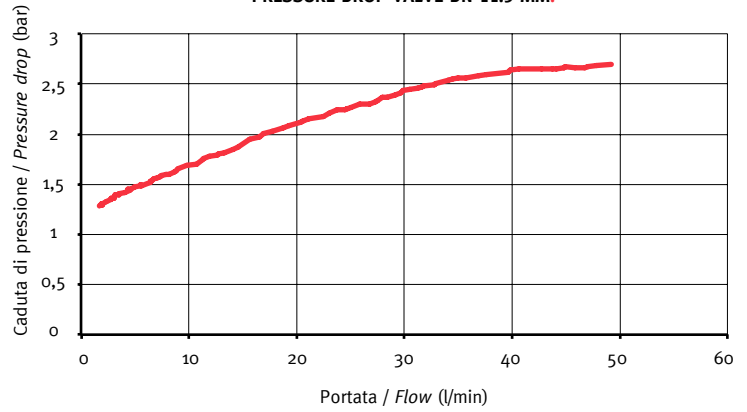

**CADUTA DI PRESSIONE VALVOLA DN 15 MM.
PRESSURE DROP VALVE DN 15 MM.**

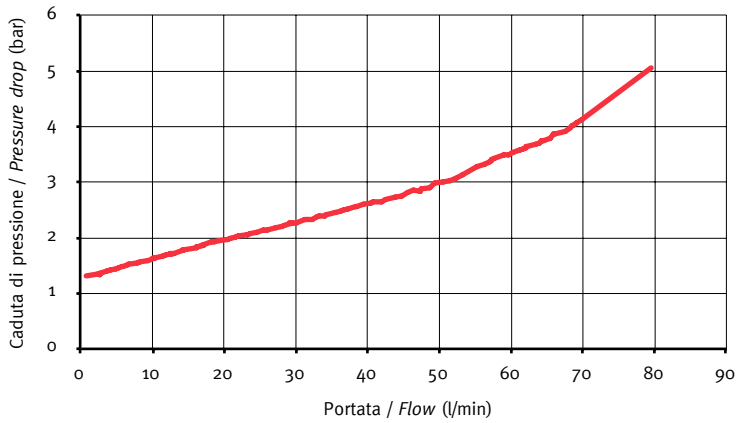

**CADUTA DI PRESSIONE VALVOLA DN 19 MM.
PRESSURE DROP VALVE DN 19 MM.**

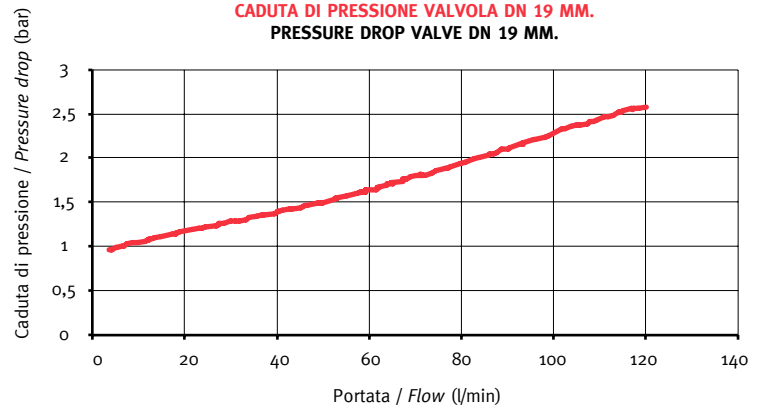

**CADUTA DI PRESSIONE VALVOLA DN 24 MM.
PRESSURE DROP VALVE DN 24 MM.**

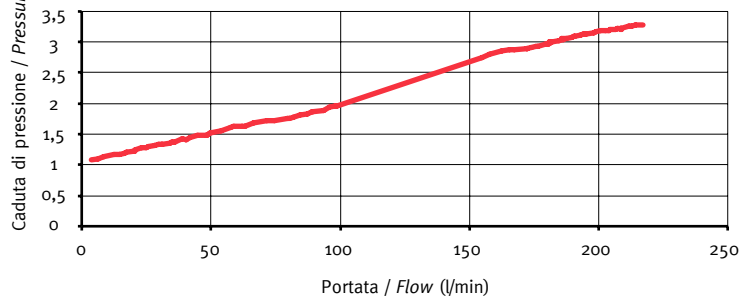

**CADUTA DI PRESSIONE VALVOLA DN 29 MM.
PRESSURE DROP VALVE DN 29 MM.**

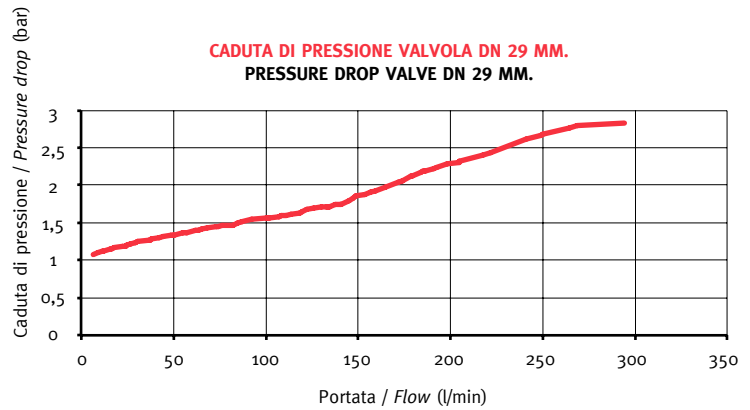



10

302598

Valvola unidirezionale
da maschio JIC ISO 8434-2
a maschio JIC ISO 8434-2 (TT)
*Non return valve
from male JIC ISO 8434-2
to male JIC ISO 8434-2 (TT)*



10

302763

Valvola unidirezionale
da maschio SAE J1926-3
a maschio JIC ISO 8434-2 (ST)
*Non return valve
from male SAE J1926-3
to male JIC ISO 8434-2 (ST)*

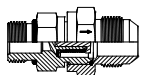

11

302774

Valvola unidirezionale
da maschio JIC ISO 8434-2
a maschio SAE J1926-3 (TS)
*Non return valve
from male JIC ISO 8434-2
to male SAE J1926-3 (TS)*



11

302653

Valvola unidirezionale
da maschio GAS ISO 1179-2
a maschio JIC ISO 8434-2 (ST)
*Non return valve
from BSPP male ISO 1179-2
to male JIC ISO 8434-2 (ST)*

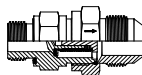

12

302752

Valvola unidirezionale
da maschio JIC ISO 8434-2
a maschio GAS con tenuta
ad elastomero ISO 1179-2 (TS)
*Non return valve
from male JIC ISO 8434-2
to BSPP male with elastomer
seal ISO 1179-2 (TS)*



12

302828

Valvola unidirezionale
da maschio metrico con tenuta
ad elastomero ISO 9974
a maschio JIC ISO 8434-2 (ST)
*Non return valve from metric male
with elastomer seal ISO 9974
to male JIC ISO 8434-2 (ST)*

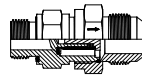

13

302839

Valvola unidirezionale
da maschio JIC ISO 8434-2
a maschio metrico con tenuta
ad elastomero ISO 9974 (TS)
*Non return valve from male
JIC ISO 8434-2 to metric male
with elastomer seal ISO 9974 (TS)*



13

302510

Valvola unidirezionale
da maschio ORFS ISO 8434-3
a maschio ORFS ISO 8434-3 (TT)
*Non return valve
from male ORFS ISO 8434-3
to male ISO 8434-3 (TT)*

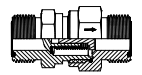

14

302543

Valvola unidirezionale
da maschio SAE J1926-2
a maschio ORFS ISO 8434-3 (ST)
*Non return valve from male
SAE J1926-2 to male
ORFS ISO 8434-3 (ST)*

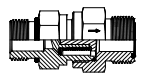

14

302532

Valvola unidirezionale
da maschio ORFS ISO 8434-3
a maschio SAE J1926-2 UNF (TS)
*Non return valve
from male ORFS ISO 8434-3
to male SAE J1926-2 UNF (TS)*



15

302587

Valvola unidirezionale da maschio GAS con elastomero ISO 1179-2 a maschio ORFS ISO 8434-3 (ST)
Non return valve from BSPP male with elastomer seal ISO 1179-2 to ORFS male ISO 8434-3 (ST)

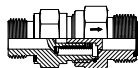

15

302576

Valvola unidirezionale da maschio ORFS ISO 8434-3 a maschio GAS con tenuta ad elastomero ISO 1179-2 (TS)
Non return valve from ORFS male ISO 8434-3 to BSPP male with elastomer seal ISO 1179-2 (TS)



16

302565

Valvola unidirezionale da maschio metrico con tenuta ad elastomero ISO 9974 a maschio ORFS ISO 8434-3 (ST)
Non return valve from metric male with elastomer seal ISO 9974 to ORFS male ISO 8434-3 (ST)

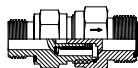

16

302554

Valvola unidirezionale da maschio ORFS ISO 8434-3 a maschio metrico con tenuta ad elastomero ISO 9974 (TS)
Non return valve from male ORFS ISO 8434-3 to metric male with elastomer seal ISO 9974 (TS)

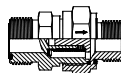

17

302620

Valvola unidirezionale da maschio DIN serie L ISO 8434-1 a maschio DIN serie L ISO 8434-1 (TT)
Non return valve from male DIN L series ISO 8434-1 to male DIN L ISO 8434-1 (TT)

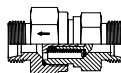

17

302741

Valvola unidirezionale da maschio DIN serie S ISO 8434-1 a maschio DIN serie S ISO 8434-1 (TT)
Non return valve from male DIN S series ISO 8434-1 to male DIN S series ISO 8434-1 (TT)

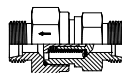

18

302642

Valvola unidirezionale da maschio GAS con tenuta ad elastomero ISO 1179-2 a maschio DIN L ISO 8434-1 (ST)
Non return valve from BSPP male with elastomer seal ISO 1179-2 to male DIN L ISO 8434-1 (ST)

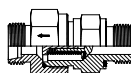

18

302697

Valvola unidirezionale da maschio DIN L ISO 8434-1 a maschio GAS ISO 1179-2 (TS)
Non return valve from male DIN L ISO 8434-1 to BSPP male ISO 1179-2 (TS)

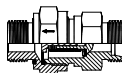

19

302817

Valvola unidirezionale da maschio GAS con tenuta ad elastomero ISO 1179-2 a maschio DIN S ISO 8434-1 (ST)
Non return valve from BSPP male with elastomer seal ISO 1179-2 to male DIN S ISO 8434-1 (ST)

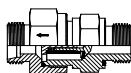

19

302730

Valvola unidirezionale da maschio DIN S ISO 8434-1 a maschio GAS con tenuta ad elastomero ISO 1179-2 (TS)
Non return valve from male DIN S ISO 8434-1 to BSPP male with elastomer seal ISO 1179-2 (TS)

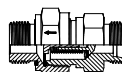

20

302664

Valvola unidirezionale da maschio metrico con tenuta ad elastomero ISO 9974 a maschio DIN L ISO 8434-1 (ST)
Non return valve from metric male with elastomer seal ISO 9974 to male DIN L ISO 8434-1 (ST)

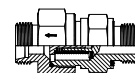

20

302718

Valvola unidirezionale da maschio DIN L ISO 8434-1 a maschio metrico con tenuta ad elastomero ISO 9974 (TS)
Non return valve from male ISO 8434-1 to metric male with elastomer seal ISO 9974 (TS)

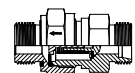

21

302806

Valvola unidirezionale da maschio metrico con tenuta ad elastomero ISO 9974 a maschio DIN S ISO 8434-1 (ST)
Non return valve from metric male with elastomer seal ISO 9974 to male DIN S ISO 8434-1 (ST)

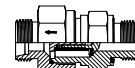

21

302796

Valvola unidirezionale da maschio DIN S ISO 8434-1 a maschio metrico con tenuta ad elastomero ISO 9974 (TS)
Non return valve from male DIN S ISO 8434-1 to metric male with elastomer seal ISO 9974 (TS)



22

302873

Valvola unidirezionale da femmina fissa GAS ISO 1179-1 a femmina fissa GAS ISO 1179-1
Non return valve from BSPP port ISO 1179-1 to BSPP port ISO 1179-1



302598

Valvola unidirezionale
da maschio JIC ISO 8434-2
a maschio JIC ISO 8434-2 (TT)
*Non return valve
from male JIC ISO 8434-2
to male JIC ISO 8434-2 (TT)*

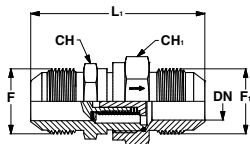

| RIFERIMENTO REFERENCE | F | F ₁ | DN | L ₁ | CH | CH ₁ | PRESSIONE ESERCIZIO WORKING PRESSURE |
|--------------------------|------------|----------------|------|----------------|----|-----------------|---|
| | UNF-UN | UNF-UN | | | | | BAR |
| A302598/0606A | 7/16-20 | 7/16-20 | 3,5 | 52,5 | 19 | 19 | 420 |
| A302598/0808A | 1/2-20 | 1/2-20 | 5,5 | 59,5 | 22 | 24 | 420 |
| A302598/1010A | 9/16-18 | 9/16-18 | 7,5 | 61,5 | 24 | 27 | 420 |
| A302598/1212A | 3/4-16 | 3/4-16 | 9,5 | 69,5 | 27 | 32 | 420 |
| A302598/1616A | 7/8-14 | 7/8-14 | 11,5 | 78,5 | 32 | 36 | 350 |
| A302598/2020A | 1" 1/16-12 | 1" 1/16-12 | 15 | 87,5 | 41 | 46 | 350 |
| A302598/2525A | 1" 5/16-12 | 1" 5/16-12 | 19 | 92,5 | 46 | 50 | 280 |
| A302598/3232A | 1" 5/8-12 | 1" 5/8-12 | 24 | 105,5 | 60 | 60 | 350 |
| A302598/3838A | 1" 7/8-12 | 1" 7/8-12 | 29 | 118,5 | 65 | 70 | 210 |

302763

Valvola unidirezionale
da maschio SAE J1926-3
a maschio JIC ISO 8434-2 (ST)
*Non return valve
from male SAE J1926-3
to male JIC ISO 8434-2 (ST)*

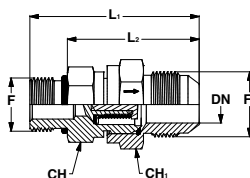

| RIFERIMENTO REFERENCE | F | F ₁ | DN | L ₁ | L ₂ | CH | CH ₁ | PRESSIONE ESERCIZIO WORKING PRESSURE |
|--------------------------|------------|----------------|------|----------------|----------------|----|-----------------|---|
| | UNF-UN | UNF-UN | | | | | | BAR |
| A302763/0611A | 7/16-20 | 7/16-20 | 3,5 | 49,5 | 38,5 | 19 | 19 | 420 |
| A302763/0812A | 1/2-20 | 1/2-20 | 5,5 | 56,5 | 45,5 | 22 | 24 | 420 |
| A302763/1014A | 9/16-18 | 9/16-18 | 7,5 | 59,5 | 47,5 | 24 | 27 | 420 |
| A302763/1219A | 3/4-16 | 3/4-16 | 9,5 | 66,5 | 52,5 | 27 | 32 | 420 |
| A302763/1622A | 7/8-14 | 7/8-14 | 11,5 | 75 | 59 | 32 | 36 | 350 |
| A302763/2027A | 1" 1/16-12 | 1" 1/16-12 | 15 | 84 | 65,5 | 41 | 46 | 350 |
| A302763/2533A | 1" 5/16-12 | 1" 5/16-12 | 19 | 88 | 69,5 | 46 | 50 | 280 |
| A302763/3241A | 1" 5/8-12 | 1" 5/8-12 | 24 | 99,5 | 81 | 60 | 60 | 250 |
| A302763/3848A | 1" 7/8-12 | 1" 7/8-12 | 29 | 109,5 | 91 | 65 | 70 | 210 |

| RIFERIMENTO REFERENCE | F | F₁ | DN | L₁ | L₂ | CH | CH₁ | PRESSIONE ESERCIZIO WORKING PRESSURE BAR |
|--------------------------|------------|----------------------|-----------|----------------------|----------------------|-----------|-----------------------|--|
| | UNF-UN | UNF-UN | | | | | | |
| A302774/0611A | 7/16-20 | 7/16-20 | 3,5 | 49,5 | 38,5 | 19 | 19 | 420 |
| A302774/0812A | 1/2-20 | 1/2-20 | 5,5 | 56,5 | 45,5 | 22 | 24 | 420 |
| A302774/1014A | 9/16-18 | 9/16-18 | 7,5 | 59,5 | 47,5 | 24 | 27 | 420 |
| A302774/1219A | 3/4-16 | 3/4-16 | 9,5 | 66,5 | 52,5 | 27 | 32 | 420 |
| A302774/1622A | 7/8-14 | 7/8-14 | 11,5 | 75 | 59 | 32 | 36 | 350 |
| A302774/2027A | 1" 1/16-12 | 1" 1/16-12 | 15 | 84 | 65,5 | 41 | 46 | 350 |
| A302774/2533A | 1" 5/16-12 | 1" 5/16-12 | 19 | 88 | 69,5 | 46 | 50 | 280 |
| A302774/3241A | 1" 5/8-12 | 1" 5/8-12 | 24 | 99,5 | 81 | 60 | 60 | 250 |
| A302774/3848A | 1" 7/8-12 | 1" 7/8-12 | 29 | 109,5 | 91 | 65 | 70 | 210 |

302774

Valvola unidirezionale
da maschio JIC ISO 8434-2
a maschio SAE J1926-3 (TS)
*Non return valve
from male JIC ISO 8434-2
to male SAE J1926-3 (TS)*

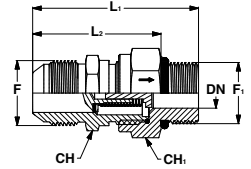

| RIFERIMENTO REFERENCE | F₁ | F | DN | L₁ | L₂ | CH | CH₁ | D | PRESSIONE ESERCIZIO WORKING PRESSURE BAR |
|--------------------------|----------------------|-----------------|-----------|----------------------|----------------------|-----------|-----------------------|----------|--|
| | UNF-UN | GAS CIL.BSPP | | | | | | | |
| A302653/0610A | 7/16-20 | 1/8 | 3,5 | 48 | 40 | 19 | 19 | 14 | 420 |
| A302653/0813A | 1/2-20 | 1/4 | 5,5 | 59,5 | 47,5 | 22 | 24 | 19 | 420 |
| A302653/1013A | 9/16-18 | 1/4 | 7,5 | 62 | 50 | 24 | 27 | 19 | 420 |
| A302653/1217A | 3/4-16 | 3/8 | 9,5 | 67 | 55 | 27 | 32 | 22 | 420 |
| A302653/1621A | 7/8-14 | 1/2 | 11,5 | 76 | 62 | 32 | 36 | 27 | 350 |
| A302653/2026A | 1" 1/16-12 | 3/4 | 15 | 84,5 | 68,5 | 41 | 46 | 32 | 350 |
| A302653/2533A | 1" 5/16-12 | 1" | 19 | 89,5 | 71,5 | 46 | 50 | 40 | 280 |
| A302653/3242A | 1" 5/8-12 | 1" 1/4 | 24 | 102 | 82 | 60 | 60 | 50 | 250 |
| A302653/3848A | 1" 7/8-12 | 1" 1/2 | 29 | 113 | 91 | 65 | 70 | 55 | 210 |

302653

Valvola unidirezionale
da maschio GAS ISO 1179-2
a maschio JIC ISO 8434-2 (ST)
*Non return valve
from BSPP male ISO 1179-2
to male JIC ISO 8434-2 (ST)*

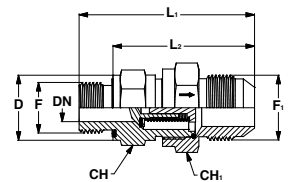

302752

Valvola unidirezionale
da maschio JIC ISO 8434-2
a maschio GAS con tenuta
ad elastomero ISO 1179-2 (TS)
*Non return valve
from male JIC ISO 8434-2
to BSPP male with elastomer seal
ISO 1179-2 (TS)*

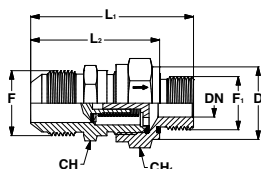

| RIFERIMENTO REFERENCE | F | F ₁ | DN | L ₁ | L ₂ | CH | CH ₁ | D | PRESSIONE ESERCIZIO WORKING PRESSURE |
|--------------------------|------------|-----------------|------|----------------|----------------|----|-----------------|----|---|
| | UNF-UN | GAS CIL.BSPP | | | | | | | BAR |
| A302752/0610A | 7/16-20 | 1/8 | 3,5 | 48 | 40 | 19 | 19 | 14 | 420 |
| A302752/0813A | 1/2-20 | 1/4 | 5,5 | 59 | 47 | 22 | 24 | 19 | 420 |
| A302752/1013A | 9/16-18 | 1/4 | 7,5 | 62 | 50 | 24 | 27 | 19 | 420 |
| A302752/1217A | 3/4-16 | 3/8 | 9,5 | 66 | 54 | 27 | 32 | 22 | 420 |
| A302752/1621A | 7/8-14 | 1/2 | 11,5 | 74 | 66 | 32 | 36 | 27 | 350 |
| A302752/2026A | 1" 1/16-12 | 3/4 | 15 | 82,5 | 66,5 | 41 | 46 | 32 | 350 |
| A302752/2533A | 1" 5/16-12 | 1" | 19 | 89,5 | 71,5 | 46 | 50 | 40 | 280 |
| A302752/3242A | 1" 5/8-12 | 1" 1/4 | 24 | 102 | 82 | 60 | 60 | 50 | 250 |
| A302752/3848A | 1" 7/8-12 | 1" 1/2 | 29 | 115 | 93 | 65 | 70 | 55 | 210 |

302828

Valvola unidirezionale
da maschio metrico con tenuta
ad elastomero ISO 9974
a maschio JIC ISO 8434-2 (ST)
*Non return valve from metric male
with elastomer seal ISO 9974
to male JIC ISO 8434-2 (ST)*

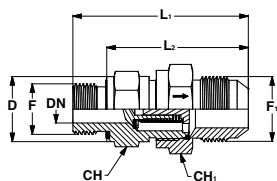

| RIFERIMENTO REFERENCE | F ₁ | F | DN | L ₁ | L ₂ | CH | CH ₁ | D | PRESSIONE ESERCIZIO WORKING PRESSURE |
|--------------------------|----------------|-------------------|------|----------------|----------------|----|-----------------|----|---|
| | UNF-UN | METRICO METRIC | | | | | | | BAR |
| A302828/0610A | 7/16-20 | 10X1 | 3,5 | 48 | 40 | 19 | 19 | 14 | 420 |
| A302828/0812A | 1/2-20 | 12X1,5 | 5,5 | 59,5 | 47,5 | 22 | 24 | 17 | 420 |
| A302828/1014A | 9/16-18 | 14X1,5 | 7,5 | 62 | 50 | 24 | 27 | 19 | 420 |
| A302828/1216A | 3/4-16 | 16X1,5 | 9,5 | 67 | 55 | 27 | 32 | 22 | 420 |
| A302828/1618A | 7/8-14 | 18X1,5 | 11,5 | 73,5 | 61,5 | 32 | 36 | 24 | 350 |
| A302828/2027A | 1" 1/16-12 | 27X2 | 15 | 84,5 | 68,5 | 41 | 46 | 32 | 350 |
| A302828/2533A | 1" 5/16-12 | 33X2 | 19 | 89,5 | 71,5 | 46 | 50 | 40 | 280 |
| A302828/3242A | 1" 5/8-12 | 42X2 | 24 | 102 | 82 | 60 | 60 | 50 | 250 |
| A302828/3848A | 1" 7/8-12 | 48X2 | 29 | 113 | 91 | 65 | 70 | 55 | 210 |

| RIFERIMENTO REFERENCE | F | F ₁ | DN | L ₁ | L ₂ | CH | CH ₁ | D | PRESSIONE ESERCIZIO WORKING PRESSURE |
|--------------------------|------------|-------------------|------|----------------|----------------|----|-----------------|----|---|
| | UNF-UN | METRICO METRIC | | | | | | | BAR |
| A302839/0610A | 7/16-20 | 10X1 | 3,5 | 48 | 40 | 19 | 19 | 14 | 420 |
| A302839/0812A | 1/2-20 | 12X1,5 | 5,5 | 59,5 | 47,5 | 22 | 24 | 17 | 420 |
| A302839/1014A | 9/16-18 | 14X1,5 | 7,5 | 62 | 50 | 24 | 27 | 19 | 420 |
| A302839/1216A | 3/4-16 | 16X1,5 | 9,5 | 66 | 54 | 27 | 32 | 22 | 420 |
| A302839/1618A | 7/8-14 | 18X1,5 | 11,5 | 71,5 | 59,5 | 32 | 36 | 24 | 350 |
| A302839/2027A | 1" 1/16-12 | 27X2 | 15 | 82,5 | 66,5 | 41 | 46 | 32 | 350 |
| A302839/2533A | 1" 5/16-12 | 33X2 | 19 | 89,5 | 71,5 | 46 | 50 | 40 | 280 |
| A302839/3242A | 1" 5/8-12 | 42X2 | 24 | 102 | 82 | 60 | 60 | 50 | 250 |
| A302839/3848A | 1" 7/8-12 | 48X2 | 29 | 115 | 93 | 65 | 70 | 55 | 210 |

302839

Valvola unidirezionale
da maschio JIC ISO 8434-2
a maschio metrico con tenuta
ad elastomero ISO 9974 (TS)
*Non return valve
from male JIC ISO 8434-2
to metric male with elastomer
seal ISO 9974 (TS)*

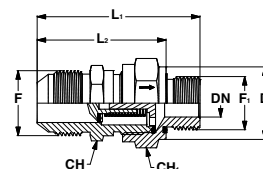

| RIFERIMENTO REFERENCE | F | F ₁ | DN | L ₁ | CH | CH ₁ | PRESSIONE ESERCIZIO WORKING PRESSURE |
|--------------------------|-------------|----------------|------|----------------|----|-----------------|---|
| | UNF-UN | UNF-UN | | | | | BAR |
| A302510/0606A | 9/16-18 | 9/16-18 | 3,5 | 44,5 | 19 | 19 | 420 |
| A302510/1010A | 11/16-16 | 11/16-16 | 5,5 | 53,5 | 22 | 24 | 420 |
| A302510/1212A | 13/16-16 | 13/16-16 | 7,5 | 59,5 | 24 | 27 | 420 |
| A302510/1616A | 1" -14 | 1" -14 | 11,5 | 70,5 | 32 | 36 | 420 |
| A302510/2020A | 1" 3/16-12 | 1" 3/16-12 | 15 | 77,5 | 41 | 46 | 420 |
| A302510/2525A | 1" 7/16-12 | 1" 7/16-12 | 19 | 81,5 | 46 | 50 | 420 |
| A302510/3232A | 1" 11/16-12 | 1" 11/16-12 | 24 | 91,5 | 60 | 60 | 250 |
| A302510/3838A | 2" -12 | 2" -12 | 29 | 98,5 | 65 | 70 | 250 |

302510

Valvola unidirezionale
da maschio ORFS ISO 8434-3
a maschio ORFS ISO 8434-3 (TT)
*Non return valve
from male ORFS ISO 8434-3
to male ISO 8434-3 (TT)*

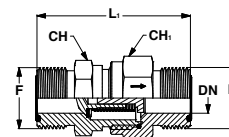

302543

Valvola unidirezionale
da maschio SAE J1926-2
a maschio ORFS ISO 8434-3 (ST)
*Non return valve
from male SAE J1926-2 to male
ORFS ISO 8434-3 (ST)*

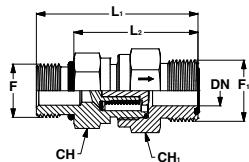
**302532**

Valvola unidirezionale
da maschio ORFS ISO 8434-3
a maschio SAE J1926-2 UNF (TS)
*Non return valve
from male ORFS ISO 8434-3
to male SAE J1926-2 UNF (TS)*

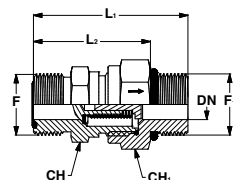

| RIFERIMENTO REFERENCE | F₁ | F | DN | L₁ | L₂ | CH | CH₁ | PRESSIONE ESERCIZIO WORKING PRESSURE |
|--------------------------|----------------------|------------|-----------|----------------------|----------------------|-----------|-----------------------|---|
| | UNF-UN | UNF-UN | | | | | | |
| A302543/0611A | 9/16-18 | 7/16-20 | 3,5 | 45,5 | 34,5 | 19 | 19 | 420 |
| A302543/1014A | 11/16-16 | 9/16-20 | 5,5 | 54,5 | 42,5 | 22 | 24 | 420 |
| A302543/1219A | 13/16-16 | 3/4-16 | 5,5 | 60,5 | 46,5 | 24 | 27 | 420 |
| A302543/1622A | 1"-14 | 7/8-14 | 11,5 | 71 | 55 | 32 | 36 | 420 |
| A302543/2027A | 1" 3/16-12 | 1" 1/16-12 | 15 | 79 | 60,5 | 41 | 46 | 420 |
| A302543/2533A | 1" 7/16-12 | 1" 5/16-12 | 19 | 82,5 | 64 | 46 | 50 | 420 |
| A302543/3241A | 1" 11/16-12 | 1" 5/8-12 | 24 | 92,5 | 74 | 60 | 60 | 250 |
| A302543/3848A | 2"-12 | 1" 7/8-12 | 29 | 99,5 | 81 | 65 | 70 | 250 |

| RIFERIMENTO REFERENCE | F | F₁ | DN | L₁ | L₂ | CH | CH₁ | PRESSIONE ESERCIZIO WORKING PRESSURE |
|--------------------------|-------------|----------------------|-----------|----------------------|----------------------|-----------|-----------------------|---|
| | UNF-UN | UNF-UN | | | | | | |
| A302532/0611A | 9/16-18 | 7/16-20 | 3,5 | 45,5 | 34,5 | 19 | 19 | 420 |
| A302532/1014A | 11/16-16 | 9/16-20 | 5,5 | 54,5 | 42,5 | 22 | 24 | 420 |
| A302532/1219A | 13/16-16 | 3/4-16 | 5,5 | 60,5 | 46,5 | 24 | 27 | 420 |
| A302532/1622A | 1"-14 | 7/8-14 | 11,5 | 71 | 55 | 32 | 36 | 420 |
| A302532/2027A | 1" 3/16-12 | 1" 1/16-12 | 15 | 79 | 60,5 | 41 | 46 | 420 |
| A302532/2533A | 1" 7/16-12 | 1" 5/16-12 | 19 | 82,5 | 64 | 46 | 50 | 420 |
| A302532/3241A | 1" 11/16-12 | 1" 5/8-12 | 24 | 92,5 | 74 | 60 | 60 | 250 |
| A302532/3848A | 2"-12 | 1" 7/8-12 | 29 | 99,5 | 81 | 65 | 70 | 250 |

| RIFERIMENTO REFERENCE | F | F₁ | DN | L₁ | L₂ | CH | CH₁ | D | PRESSIONE ESERCIZIO WORKING PRESSURE BAR |
|--------------------------|------------|----------------------|-----------|----------------------|----------------------|-----------|-----------------------|----------|--|
| | UNF-UN | GAS CIL.BSPP | | | | | | | |
| A302587/0610A | 9/16-18 | 1/8 | 3,5 | 44,5 | 36,5 | 19 | 19 | 14 | 420 |
| A302587/1013A | 11/16-16 | 1/4 | 7,5 | 56,5 | 44,5 | 24 | 27 | 19 | 420 |
| A302587/1217A | 13/16-16 | 3/8 | 7,5 | 61,5 | 49,5 | 24 | 27 | 22 | 420 |
| A302587/1621A | 1"-14 | 1/2 | 11,5 | 70 | 56 | 32 | 36 | 27 | 420 |
| A302587/2026A | 1"3/16-12 | 3/4 | 15 | 77,5 | 63,5 | 41 | 46 | 32 | 420 |
| A302587/2533A | 1" 7/16-12 | 1" | 19 | 84 | 66 | 46 | 50 | 40 | 420 |
| A302587/3242A | 1"11/16-12 | 1" 1/4 | 24 | 95 | 75 | 60 | 60 | 50 | 250 |
| A302587/3848A | 2"-12 | 1" 1/2 | 29 | 105 | 83 | 65 | 70 | 55 | 250 |

302587

Valvola unidirezionale da maschio
GAS con elastomero ISO 1179-2
a maschio ORFS ISO 8434-3 (ST)
*Non return valve from BSPP male
with elastomer seal ISO 1179-2
to ORFS male ISO 8434-3 (ST)*

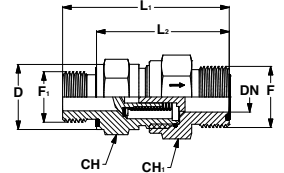

| RIFERIMENTO REFERENCE | F | F₁ | DN | L₁ | L₂ | CH | CH₁ | D₁ | PRESSIONE ESERCIZIO WORKING PRESSURE BAR |
|--------------------------|------------|----------------------|-----------|----------------------|----------------------|-----------|-----------------------|----------------------|--|
| | UNF-UN | GAS CIL.BSPP | | | | | | | |
| A302576/0610A | 9/16-18 | 1/8 | 3,5 | 44,5 | 36,5 | 19 | 19 | 14 | 420 |
| A302576/1013A | 11/16-16 | 1/4 | 7,5 | 56,5 | 44,5 | 24 | 27 | 19 | 420 |
| A302576/1217A | 13/16-16 | 3/8 | 7,5 | 61,5 | 49,5 | 24 | 27 | 22 | 420 |
| A302576/1621A | 1"-14 | 1/2 | 11,5 | 70 | 56 | 32 | 36 | 27 | 420 |
| A302576/2026A | 1"3/16-12 | 3/4 | 15 | 77,5 | 63,5 | 41 | 46 | 32 | 420 |
| A302576/2533A | 1"7/16-12 | 1" | 19 | 84 | 66 | 46 | 50 | 40 | 420 |
| A302576/3242A | 1"11/16-12 | 1" 1/4 | 24 | 95 | 75 | 60 | 60 | 50 | 250 |
| A302576/3848A | 2"-12 | 1" 1/2 | 29 | 105 | 83 | 65 | 70 | 55 | 250 |

302576

Valvola unidirezionale
da maschio ORFS ISO 8434-3
a maschio GAS con tenuta
ad elastomero ISO 1179-2 (TS)
*Non return valve
from ORFS male ISO 8434-3
to BSPP male with elastomer
seal ISO 1179-2 (TS)*

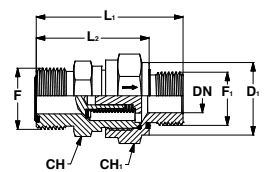

302565

Valvola unidirezionale
da maschio metrico con tenuta
ad elastomero ISO 9974
a maschio ORFS ISO 8434-3 (ST)
*Non return valve
from metric male
with elastomer seal ISO 9974
to ORFS male ISO 8434-3 (ST)*

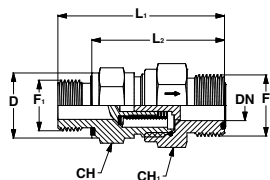
**302554**

Valvola unidirezionale
da maschio ORFS ISO 8434-3
a maschio metrico con tenuta
ad elastomero ISO 9974 (TS)
*Non return valve
from male ORFS ISO 8434-3
to metric male with elastomer
seal ISO 9974 (TS)*

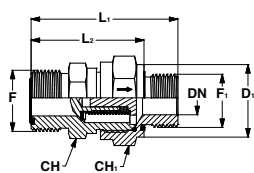

| RIFERIMENTO REFERENCE | F | F ₁ | DN | L ₁ | L ₂ | CH | CH ₁ | D | PRESSIONE ESERCIZIO WORKING PRESSURE |
|--------------------------|-------------|-------------------|------|----------------|----------------|----|-----------------|----|---|
| | UNF-UN | METRICO METRIC | | | | | | | BAR |
| A302565/0612A | 9/16-18 | 12X1,5 | 3,5 | 48,5 | 36,5 | 19 | 19 | 17 | 420 |
| A302565/1016A | 11/16-16 | 16X1,5 | 5,5 | 56,5 | 44,5 | 22 | 24 | 22 | 420 |
| A302565/1218A | 13/16-16 | 18X1,5 | 7,5 | 61,5 | 49,5 | 24 | 27 | 24 | 420 |
| A302565/1622A | 1"-14 | 22X1,5 | 11,5 | 72 | 58 | 32 | 36 | 27 | 420 |
| A302565/2027A | 1" 3/16-12 | 27X2 | 15 | 79,5 | 63,5 | 41 | 46 | 32 | 420 |
| A302565/2533A | 1" 7/16-12 | 33X2 | 19 | 84 | 66 | 46 | 50 | 40 | 420 |
| A302565/3242A | 1" 11/16-12 | 42X2 | 24 | 95 | 75 | 60 | 60 | 50 | 250 |
| A302565/3848A | 2"-12 | 48X2 | 29 | 103 | 81 | 65 | 70 | 55 | 250 |

| RIFERIMENTO REFERENCE | F | F ₁ | DN | L ₁ | L ₂ | CH | CH ₁ | D ₁ | PRESSIONE ESERCIZIO WORKING PRESSURE |
|--------------------------|-------------|-------------------|------|----------------|----------------|----|-----------------|----------------|---|
| | UNF-UN | METRICO METRIC | | | | | | | BAR |
| A302554/0612A | 9/16-18 | 12X1,5 | 3,5 | 48,5 | 36,5 | 19 | 19 | 17 | 420 |
| A302554/1016A | 11/16-16 | 16X1,5 | 7,5 | 59,1 | 47,1 | 24 | 27 | 22 | 420 |
| A302554/1218A | 13/16-16 | 18X1,5 | 7,5 | 61,5 | 49,5 | 24 | 27 | 24 | 420 |
| A302554/1622A | 1"-14 | 22X1,5 | 11,5 | 70 | 56 | 32 | 36 | 27 | 420 |
| A302554/2027A | 1" 3/16-12 | 27X2 | 15 | 77,5 | 61,5 | 41 | 50 | 32 | 420 |
| A302554/2533A | 1" 7/16-12 | 33X2 | 19 | 84 | 66 | 46 | 55 | 40 | 420 |
| A302554/3242A | 1" 11/16-12 | 42X2 | 24 | 95 | 75 | 60 | 60 | 50 | 250 |
| A302554/3848A | 2"-12 | 48X2 | 29 | 115 | 93 | 65 | 70 | 55 | 250 |

| RIFERIMENTO REFERENCE | T | T ₁ | F | F ₁ | DN | L ₁ | L ₂ | CH | CH ₁ | PRESSIONE ESERCIZIO WORKING PRESSURE |
|--------------------------|-----|----------------|--------|----------------|------|----------------|----------------|----|-----------------|---|
| | | | | | | | | | | BAR |
| A302620/0606A | 06L | 06L | 12x1,5 | 12x1,5 | 3,5 | 43 | 29 | 17 | 17 | 400 |
| A302620/0808A | 08L | 08L | 14x1,5 | 14x1,5 | 5,5 | 44 | 30 | 19 | 19 | 400 |
| A302620/1010A | 10L | 10L | 16x1,5 | 16x1,5 | 7,5 | 55 | 40,5 | 22 | 24 | 400 |
| A302620/1212A | 12L | 12L | 18x1,5 | 18x1,5 | 9,5 | 58 | 43,5 | 27 | 30 | 400 |
| A302620/1515A | 15L | 15L | 22x1,5 | 22x1,5 | 11,5 | 62 | 47,5 | 27 | 32 | 400 |
| A302620/1818A | 18L | 18L | 26x1,5 | 26x1,5 | 15 | 67 | 51,5 | 36 | 41 | 400 |
| A302620/2222A | 22L | 22L | 30x2 | 30x2 | 19 | 77 | 61,5 | 41 | 46 | 250 |
| A302620/2828A | 28L | 28L | 36x2 | 36x2 | 24 | 85 | 69,5 | 50 | 55 | 250 |
| A302620/3535A | 35L | 35L | 45x2 | 45x2 | 29 | 96 | 74,5 | 60 | 65 | 250 |
| A302620/4242A | 42L | 42L | 52x2 | 52x2 | 29 | 96 | 74 | 65 | 70 | 250 |

302620

Valvola unidirezionale
da maschio DIN serie L ISO 8434-1
a maschio DIN serie L ISO 8434-1 (TT)
*Non return valve
from male DIN L series ISO 8434-1
to male DIN L ISO 8434-1 (TT)*

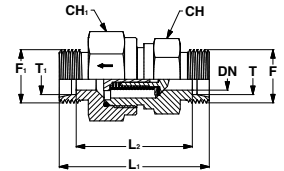

| RIFERIMENTO REFERENCE | T | T ₁ | F | F ₁ | DN | L ₁ | L ₂ | CH | CH ₁ | PRESSIONE ESERCIZIO WORKING PRESSURE |
|--------------------------|-----|----------------|--------|----------------|------|----------------|----------------|----|-----------------|---|
| | | | | | | | | | | BAR |
| A302741/0606A | 06S | 06S | 14x1,5 | 14x1,5 | 3,5 | 48,5 | 34,5 | 19 | 19 | 420 |
| A302741/0808A | 08S | 08S | 16x1,5 | 16x1,5 | 3,5 | 48,5 | 34,5 | 19 | 19 | 420 |
| A302741/1010A | 10S | 10S | 18x1,5 | 18x1,5 | 5,5 | 55,5 | 40,5 | 22 | 24 | 420 |
| A302741/1212A | 12S | 12S | 20x1,5 | 20x1,5 | 7,5 | 57,5 | 42,5 | 24 | 27 | 420 |
| A302741/1414A | 14S | 14S | 22x1,5 | 22x1,5 | 9,5 | 64 | 47,5 | 27 | 32 | 420 |
| A302741/1616A | 16S | 16S | 24x1,5 | 24x1,5 | 11,5 | 68 | 50,5 | 32 | 36 | 420 |
| A302741/2020A | 20S | 20S | 30x2 | 30x2 | 15 | 76 | 54,5 | 41 | 50 | 420 |
| A302741/2525A | 25S | 25S | 36x2 | 36x2 | 19 | 83 | 58,5 | 46 | 55 | 420 |
| A302741/3030A | 30S | 30S | 42x2 | 42x2 | 24 | 97 | 69,5 | 60 | 60 | 250 |
| A302741/3838A | 38S | 38S | 52x2 | 52x2 | 29 | 108 | 75,5 | 65 | 70 | 250 |

302741

Valvola unidirezionale
da maschio DIN serie S ISO 8434-1
a maschio DIN serie S ISO 8434-1 (TT)
*Non return valve
from male DIN S series ISO 8434-1
to male DIN S series ISO 8434-1 (TT)*

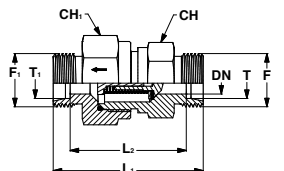

302642

Valvola unidirezionale
da maschio GAS con tenuta
ad elastomero ISO 1179-2
a maschio DIN L ISO 8434-1 (ST)
*Non return valve from BSPP male
with elastomer seal ISO 1179-2
to male DIN L 8434-1 (ST)*

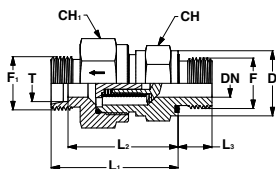

| RIFERIMENTO REFERENCE | F GAS CIL.BSPP | D | T | F1 METRICO METRIC | DN | L1 | L2 | L3 | CH | CH1 | PRESSIONE ESERCIZIO WORKING PRESSURE BAR |
|--------------------------|----------------------|----|-----|-------------------------|------|----|------|----|----|-----|--|
| A302642/0610A | 1/8 | 14 | 06L | 12x1,5 | 3,5 | 35 | 28 | 8 | 17 | 17 | 400 |
| A302642/0813A | 1/4 | 19 | 08L | 14x1,5 | 5,5 | 37 | 30 | 12 | 19 | 19 | 400 |
| A302642/1013A | 1/4 | 19 | 10L | 16x1,5 | 7,5 | 46 | 38,5 | 12 | 22 | 24 | 400 |
| A302642/1217A | 3/8 | 22 | 12L | 18x1,5 | 9,5 | 50 | 42,5 | 12 | 27 | 30 | 400 |
| A302642/1521A | 1/2 | 27 | 15L | 22x1,5 | 11,5 | 53 | 45,5 | 14 | 27 | 32 | 400 |
| A302642/1821A | 1/2 | 27 | 18L | 26x1,5 | 15 | 58 | 50 | 14 | 36 | 41 | 400 |
| A302642/2226A | 3/4 | 32 | 22L | 30x2 | 19 | 63 | 55 | 16 | 41 | 46 | 250 |
| A302642/2833A | 1" | 40 | 28L | 36x2 | 24 | 71 | 63 | 18 | 50 | 55 | 250 |
| A302642/3542A | 1" 1/4 | 50 | 35L | 45x2 | 29 | 80 | 69 | 20 | 60 | 65 | 250 |
| A302642/4248A | 1" 1/2 | 55 | 42L | 52x2 | 29 | 80 | 68,5 | 22 | 65 | 70 | 250 |

302697

Valvola unidirezionale
da maschio DIN L ISO 8434-1
a maschio GAS ISO 1179-2 (TS)
*Non return valve
from male DIN L ISO 8434-1
to BSPP male ISO 1179-2 (TS)*

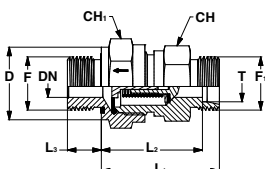

| RIFERIMENTO REFERENCE | F GAS CIL.BSPP | D | F1 METRICO METRIC | T | DN | L1 | L2 | L3 | CH | CH1 | PRESSIONE ESERCIZIO WORKING PRESSURE BAR |
|--------------------------|----------------------|----|-------------------------|-----|------|------|------|----|----|-----|--|
| A302697/0610A | 1/8 | 14 | 12x1,5 | 06L | 3,5 | 33,5 | 26,5 | 8 | 17 | 17 | 400 |
| A302697/0813A | 1/4 | 19 | 14x1,5 | 08L | 5,5 | 35,5 | 28,5 | 12 | 19 | 19 | 400 |
| A302697/1013A | 1/4 | 19 | 16x1,5 | 10L | 7,5 | 46 | 38,5 | 12 | 22 | 24 | 400 |
| A302697/1217A | 3/8 | 22 | 18x1,5 | 12L | 9,5 | 48 | 40,5 | 12 | 27 | 30 | 400 |
| A302697/1521A | 1/2 | 27 | 22x1,5 | 15L | 11,5 | 50 | 42,5 | 14 | 27 | 32 | 400 |
| A302697/1821A | 1/2 | 27 | 26x1,5 | 18L | 15 | 56 | 48 | 14 | 36 | 41 | 400 |
| A302697/2226A | 3/4 | 32 | 30x2 | 22L | 19 | 64 | 56 | 16 | 41 | 46 | 400 |
| A302697/2833A | 1" | 40 | 36x2 | 28L | 24 | 72 | 64 | 18 | 50 | 55 | 400 |
| A302697/3542A | 1" 1/4 | 50 | 45x2 | 35L | 29 | 81 | 70 | 20 | 60 | 65 | 250 |
| A302697/4248A | 1" 1/2 | 55 | 52x2 | 42L | 29 | 82 | 70,5 | 22 | 65 | 70 | 250 |

| RIFERIMENTO REFERENCE | F | T | F₁ | DN | D | L₁ | L₂ | L₃ | CH | CH₁ | PRESSIONE ESERCIZIO WORKING PRESSURE BAR |
|--------------------------|------------------|----------|----------------------|-----------|----------|----------------------|----------------------|----------------------|-----------|-----------------------|--|
| | GAS CIL. BSPP | | METRICO METRIC | | | | | | | | |
| A302817/0613A | 1/4 | 06S | 14x1,5 | 3,5 | 19 | 38,5 | 31,5 | 12 | 19 | 19 | 420 |
| A302817/0813A | 1/4 | 08S | 16x1,5 | 3,5 | 19 | 38,5 | 31,5 | 12 | 19 | 19 | 420 |
| A302817/1017A | 3/8 | 10S | 18x1,5 | 5,5 | 22 | 45,5 | 38 | 12 | 22 | 24 | 420 |
| A302817/1217A | 3/8 | 12S | 20x1,5 | 7,5 | 22 | 48,5 | 41 | 12 | 24 | 27 | 420 |
| A302817/1421A | 1/2 | 14S | 22x1,5 | 9,5 | 27 | 53 | 44,5 | 14 | 27 | 32 | 420 |
| A302817/1621A | 1/2 | 16S | 24x1,5 | 11,5 | 27 | 57 | 48 | 14 | 32 | 36 | 420 |
| A302817/2026A | 3/4 | 20S | 30x2 | 15 | 32 | 63 | 52 | 16 | 41 | 50 | 420 |
| A302817/2533A | 1" | 25S | 36x2 | 19 | 40 | 67 | 54,5 | 18 | 46 | 55 | 420 |
| A302817/3042A | 1" 1/4 | 30S | 42x2 | 24 | 50 | 78 | 64 | 20 | 60 | 60 | 250 |
| A302817/3848A | 1" 1/2 | 38S | 52x2 | 29 | 55 | 86 | 69,5 | 22 | 65 | 70 | 250 |

302817

Valvola unidirezionale da maschio GAS con tenuta ad elastomero ISO 1179-2 a maschio DIN S ISO 8434-1 (ST)
Non return valve from BSPP male with elastomer seal ISO 1179-2 to male DIN S ISO 8434-1 (ST)

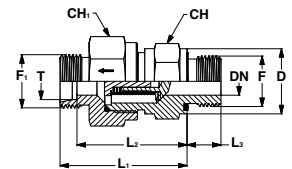

| RIFERIMENTO REFERENCE | F | F₁ | T | DN | D | L₁ | L₂ | L₃ | CH | CH₁ | PRESSIONE ESERCIZIO WORKING PRESSURE BAR |
|--------------------------|------------------|----------------------|----------|-----------|----------|----------------------|----------------------|----------------------|-----------|-----------------------|--|
| | GAS CIL. BSPP | METRICO METRIC | | | | | | | | | |
| A302730/0613A | 1/4 | 14x1,5 | 06S | 3,5 | 19 | 38,5 | 31,5 | 12 | 19 | 19 | 420 |
| A302730/0813A | 1/4 | 16x1,5 | 08S | 3,5 | 19 | 38,5 | 31,5 | 12 | 19 | 19 | 420 |
| A302730/1017A | 3/8 | 18x1,5 | 10S | 5,5 | 22 | 45,5 | 38 | 12 | 22 | 24 | 420 |
| A302730/1217A | 3/8 | 20x1,5 | 12S | 7,5 | 22 | 48,5 | 41 | 12 | 24 | 27 | 420 |
| A302730/1421A | 1/2 | 22x1,5 | 14S | 9,5 | 27 | 52 | 43,5 | 14 | 27 | 32 | 420 |
| A302730/1621A | 1/2 | 24x1,5 | 16S | 11,5 | 27 | 55 | 46 | 14 | 32 | 36 | 420 |
| A302730/2026A | 3/4 | 30x2 | 20S | 15 | 32 | 61 | 50 | 16 | 41 | 46 | 420 |
| A302730/2533A | 1" | 36x2 | 25S | 19 | 40 | 67 | 54,5 | 18 | 46 | 50 | 420 |
| A302730/3042A | 1" 1/4 | 42x2 | 30S | 24 | 50 | 78 | 64 | 20 | 60 | 60 | 250 |
| A302730/3848A | 1" 1/2 | 52x2 | 38S | 29 | 55 | 88 | 71,5 | 22 | 65 | 70 | 250 |

302730

Valvola unidirezionale da maschio DIN S ISO 8434-1 a maschio GAS con tenuta ad elastomero ISO 1179-2 (TS)
Non return valve from male DIN S ISO 8434-1 to BSPP male with elastomer seal ISO 1179-2 (TS)

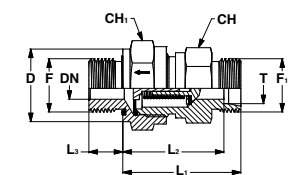

302664

Valvola unidirezionale
da maschio metrico con tenuta
ad elastomero ISO 9974
a maschio DIN L ISO 8434-1 (ST)
*Non return valve from metric male
with elastomer seal ISO 9974
to male DIN L ISO 8434-1 (ST)*

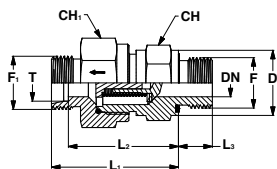

| RIFERIMENTO REFERENCE | F METRICO METRIC | D | F ₁ METRICO METRIC | T | DN | L ₁ | L ₂ | L ₃ | CH | CH ₁ | PRESSIONE ESERCIZIO WORKING PRESSURE BAR |
|--------------------------|------------------------|----|-------------------------------------|-----|------|----------------|----------------|----------------|----|-----------------|--|
| A302664/0610A | 10X1 | 14 | 12x1,5 | 06L | 3,5 | 35 | 28 | 8 | 17 | 17 | 400 |
| A302664/0812A | 12X1,5 | 17 | 14x1,5 | 08L | 5,5 | 36 | 29 | 12 | 19 | 19 | 400 |
| A302664/1014A | 14X1,5 | 19 | 16x1,5 | 10L | 7,5 | 45,5 | 38,5 | 12 | 22 | 24 | 400 |
| A302664/1216A | 16X1,5 | 22 | 18x1,5 | 12L | 9,5 | 49,5 | 42,5 | 12 | 27 | 30 | 400 |
| A302664/1518A | 18X1,5 | 24 | 22x1,5 | 15L | 11,5 | 52,5 | 45,5 | 12 | 27 | 32 | 400 |
| A302664/1822A | 22X1,5 | 27 | 26x1,5 | 18L | 15 | 56 | 50 | 14 | 36 | 41 | 400 |
| A302664/2226A | 26X1,5 | 32 | 30x2 | 22L | 19 | 64 | 55 | 16 | 41 | 46 | 250 |
| A302664/2833A | 33X2 | 40 | 36x2 | 28L | 24 | 72 | 63 | 18 | 50 | 55 | 250 |
| A302664/3542A | 42X2 | 50 | 45x2 | 35L | 29 | 81 | 69 | 20 | 60 | 65 | 250 |
| A302664/4248A | 48X2 | 55 | 52x2 | 42L | 29 | 82 | 68,5 | 22 | 65 | 70 | 250 |

302718

Valvola unidirezionale
da maschio DIN L ISO 8434-1
a maschio metrico con tenuta
ad elastomero ISO 9974 (TS)
*Non return valve from male
ISO 8434-1 to metric male
with elastomer seal ISO 9974 (TS)*

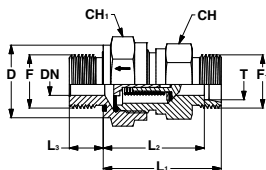

| RIFERIMENTO REFERENCE | F ₁ METRICO METRIC | T | F METRICO METRIC | DN | D | L ₁ | L ₂ | L ₃ | CH | CH ₁ | PRESSIONE ESERCIZIO WORKING PRESSURE BAR |
|--------------------------|-------------------------------------|-----|------------------------|------|----|----------------|----------------|----------------|----|-----------------|--|
| A302718/0610A | 12x1,5 | 06L | 10X1 | 3,5 | 14 | 33,5 | 26,5 | 8 | 17 | 17 | 400 |
| A302718/0812A | 14x1,5 | 08L | 12X1,5 | 5,5 | 17 | 35,5 | 28,5 | 12 | 19 | 19 | 400 |
| A302718/1014A | 16x1,5 | 10L | 14X1,5 | 7,5 | 19 | 45,5 | 38,5 | 12 | 22 | 24 | 400 |
| A302718/1216A | 18x1,5 | 12L | 16X1,5 | 9,5 | 22 | 47,5 | 40,5 | 12 | 27 | 30 | 400 |
| A302718/1518A | 22x1,5 | 15L | 18X1,5 | 11,5 | 24 | 49,5 | 42,5 | 12 | 27 | 32 | 400 |
| A302718/1822A | 26x1,5 | 18L | 22X1,5 | 15 | 27 | 55,5 | 48 | 14 | 36 | 41 | 400 |
| A302718/2226A | 30x2 | 22L | 26X1,5 | 19 | 32 | 63,5 | 56 | 16 | 41 | 46 | 250 |
| A302718/2833A | 36x2 | 28L | 33X2 | 24 | 40 | 71,5 | 64 | 18 | 50 | 55 | 250 |
| A302718/3542A | 45x2 | 35L | 42X2 | 29 | 50 | 80,5 | 70 | 20 | 60 | 65 | 250 |
| A302718/4248A | 52x2 | 42L | 48X2 | 29 | 55 | 81,5 | 70,5 | 22 | 65 | 70 | 250 |

| RIFERIMENTO REFERENCE | F | D | T | F₁ | DN | L₁ | L₂ | L₃ | CH | CH₁ | PRESSIONE ESERCIZIO WORKING PRESSURE BAR |
|--------------------------|-------------------|----------|----------|----------------------|-----------|----------------------|----------------------|----------------------|-----------|-----------------------|--|
| | METRICO METRIC | | | METRICO METRIC | | | | | | | |
| A302806/0612A | 12X1,5 | 17 | 06S | 14x1,5 | 3,5 | 38,5 | 31,5 | 12 | 19 | 19 | 420 |
| A302806/0814A | 14X1,5 | 19 | 08S | 16x1,5 | 3,5 | 38,5 | 31,5 | 12 | 19 | 19 | 420 |
| A302806/1016A | 16X1,5 | 22 | 10S | 18x1,5 | 5,5 | 45,5 | 38 | 12 | 22 | 24 | 420 |
| A302806/1218A | 18X1,5 | 24 | 12S | 20x1,5 | 7,5 | 48,5 | 41 | 12 | 24 | 27 | 420 |
| A302806/1420A | 20X1,5 | 26 | 14S | 22x1,5 | 9,5 | 52,5 | 44,5 | 14 | 27 | 32 | 420 |
| A302806/1622A | 22X1,5 | 27 | 16S | 24x1,5 | 11,5 | 55 | 48 | 14 | 32 | 36 | 420 |
| A302806/2027A | 27X2 | 32 | 20S | 30x2 | 15 | 61 | 52 | 16 | 41 | 50 | 420 |
| A302806/2533A | 33X2 | 40 | 25S | 36x2 | 19 | 67 | 54,5 | 18 | 46 | 55 | 420 |
| A302806/3042A | 42X2 | 50 | 30S | 42x2 | 24 | 78 | 64 | 20 | 60 | 60 | 250 |
| A302806/3848A | 48X2 | 55 | 38S | 52x2 | 29 | 88 | 69,5 | 22 | 65 | 70 | 250 |

302806

Valvola unidirezionale da maschio metrico con tenuta ad elastomero ISO 9974 a maschio DIN S ISO 8434-1 (ST)
Non return valve from metric male with elastomer seal ISO 9974 to male DIN S ISO 8434-1 (ST)

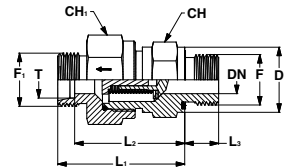

| RIFERIMENTO REFERENCE | F | F₁ | T | DN | D | L₁ | L₂ | L₃ | CH | CH₁ | PRESSIONE ESERCIZIO WORKING PRESSURE BAR |
|--------------------------|-------------------|----------------------|----------|-----------|----------|----------------------|----------------------|----------------------|-----------|-----------------------|--|
| | METRICO METRIC | METRICO METRIC | | | | | | | | | |
| A302796/0612A | 12X1,5 | 14x1,5 | 06S | 3,5 | 17 | 38,5 | 31,5 | 12 | 19 | 19 | 420 |
| A302796/0814A | 14X1,5 | 16x1,5 | 08S | 3,5 | 19 | 38,5 | 31,5 | 12 | 19 | 19 | 420 |
| A302796/1016A | 16X1,5 | 18x1,5 | 10S | 5,5 | 22 | 45,5 | 38 | 12 | 22 | 24 | 420 |
| A302796/1218A | 18X1,5 | 20x1,5 | 12S | 7,5 | 24 | 48,5 | 41 | 12 | 24 | 27 | 420 |
| A302796/1420A | 20X1,5 | 22x1,5 | 14S | 9,5 | 26 | 51,5 | 43,5 | 14 | 27 | 32 | 420 |
| A302796/1622A | 22X1,5 | 24x1,5 | 16S | 11,5 | 27 | 54,5 | 46 | 14 | 32 | 36 | 420 |
| A302796/2027A | 27X2 | 30x2 | 20S | 15 | 32 | 60,5 | 50 | 16 | 41 | 50 | 420 |
| A302796/2533A | 33X2 | 36x2 | 25S | 19 | 40 | 68 | 54,5 | 18 | 46 | 55 | 420 |
| A302796/3042A | 42X2 | 42x2 | 30S | 24 | 50 | 77,5 | 64 | 20 | 60 | 60 | 250 |
| A302796/3848A | 48X2 | 52x2 | 38S | 29 | 55 | 87,5 | 71,5 | 22 | 65 | 70 | 250 |

302796

Valvola unidirezionale da maschio DIN S ISO 8434-1 a maschio metrico con tenuta ad elastomero ISO 9974 (TS)
Non return valve from male DIN S ISO 8434-1 to metric male with elastomer seal ISO 9974 (TS)

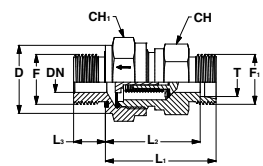

302873

Valvola unidirezionale
da femmina fissa GAS ISO 1179-1
a femmina fissa GAS ISO 1179-1
*Non return valve
from BSPP port ISO 1179-1
to BSPP port ISO 1179-1*

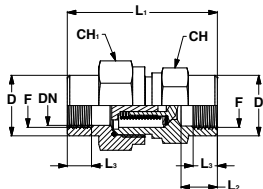

| RIFERIMENTO REFERENCE | F | DN | D | L1 | L2 | L3 | CH | CH1 | PRESSIONE ESERCIZIO WORKING PRESSURE |
|--------------------------|--------|------|----|------|------|------|----|-----|---|
| A302873/10A | 1/8 | 3,5 | 19 | 42,5 | 12 | 8 | 19 | 19 | 400 |
| A302873/13A | 1/4 | 3,5 | 19 | 51 | 16 | 12 | 19 | 19 | 400 |
| A302873/17A | 3/8 | 7,5 | 24 | 60 | 17 | 12 | 24 | 27 | 400 |
| A302873/21A | 1/2 | 11,5 | 32 | 72 | 20 | 15 | 32 | 36 | 315 |
| A302873/26A | 3/4 | 15 | 41 | 84 | 22 | 16,5 | 41 | 46 | 250 |
| A302873/33A | 1" | 19 | 46 | 95 | 25,5 | 19 | 46 | 50 | 250 |
| A302873/42A | 1" 1/4 | 24 | 60 | 110 | 28 | 21,5 | 60 | 60 | 250 |
| A302873/48A | 1" 1/2 | 29 | 65 | 114 | 28,5 | 22 | 65 | 70 | 250 |



SISTEMA DI GESTIONE AMBIENTALE
CERTIFICATO IN CONFORMITÀ
ALLA NORMA ISO 14001:2004
ENVIRONMENTAL MANAGEMENT SYSTEM
CERTIFIED IN COMPLIANCE
WITH THE STANDARD ISO14001:2004



SISTEMA DI GESTIONE DELLA QUALITÀ
CERTIFICATO IN CONFORMITÀ ALLE NORME
ISO 9001:2008 E ISO/TS 16949:2009
QUALITY MANAGEMENT SYSTEM CERTIFIED
IN COMPLIANCE WITH THE STANDARDS
ISO 9001:2008 AND ISO/TS 16949:2009



SISTEMA DI GESTIONE SALUTE E SICUREZZA
SUL LAVORO CERTIFICATO IN CONFORMITÀ
ALLA NORMA OHSAS 18001:2007
HEALT AND SAFETY MANAGEMENT SYSTEM
CERTIFIED IN COMPLIANCE WITH THE STANDARD
OHSAS 18001:2007

FOR S.p.a. Strada Comunale Segadizzo, 2/A 44028 Poggio Renatico Ferrara (Italia) tel. +39 0532 825211 fax +39 0532 825798 email: for@forfittings.it

W W W . F O R F I T T I N G S . I T